

VEGETABLE CUTTING MACHINE

USE – MAINTENANCE

HLC-300



CONTENTS

- 1、 INFORMATION ON SAFETIES
- 2、 PERFORMANCE PARAMETER
- 3、 INSTALLATION
- 4、 OPERATION INSTRUCTIONS
- 5、 CLEANING AND MAINTENANCE
- 6、 DISK
- 7、 EXPLODED DRAWING1
- 8、 CIRCUIT DIAGRAM

1. INFORMATION ON SAFETIES

1.1. GENERAL PRECAUTIONS

- THE VEGETABLES CUTTING MACHINE MUST BE MANAGED BY SKILLED PERSONNEL, FAMILIAR WITH THE INSTRUCTIONS FOR USE AND SAFETY CONTAINED IN THIS MANUAL.
- EVEN IF THE MACHINE COMES WITH SEVERAL SAFETY SYSTEMS, AVOID SETTING THE HANDS NEAR THE CUTTING DISCS AND MOVING PARTS.
- BEFORE ANY CLEANING AND MAINTENANCE OPERATIONS, CHECK TO MAKE SURE THE MACHINE IS DISCONNECTED FROM THE MAINS.
- PERIODICALLY CHECK CABLES AND ELECTRIC ELEMENTS CONDITIONS.
- NEVER USE THE CUTTING MACHINE WITH FROZEN FOOD.
- NEVER REPLACE PARTS OF THE MACHINE BY YOURSELF, BUT APPLY TO THE ASSISTANCE SERVICE.
- THE APPLIANCE CAN NOT BE USED BY THE DISABLED OR CHILDREN OR BY A LACK OF EXPERIENCE AND KNOWLEDGE OF THE PEOPLE TO USE, EXCEPT BY THE RIGHT PERSON RESPONSIBLE FOR THEIR SAFETY SUPERVISION OR INSTRUCTION CONCERNING USE OF THE APPLIANCE.

1.2 ELECTRICAL SAFETIES

THERE ARE TWO MICRO-SWITCHES ON THE COVER OF THE MACHINE, THEIR ROLE ARE: 1. WHEN LIFTING CRESCENT-SHAPED INLET PRESSURE HANDLE TO A CERTAIN HEIGHT, THE MACHINE STOPS RUNNING, IN ORDER TO PREVENT ACCIDENTALLY INSERT YOUR HANDS INTO CRESCENT-SHAPED INLET AND BE INJURED BY THE MACHINE; 2. WHEN YOU OPEN THE COVER UP, THE MACHINE STOPS RUNNING, TO ENSURE SAFE OPERATION.

A RELAY REQUIRING REQUIRES THE VOLUNTARY RESTART (ACTIVATION) OF THE MACHINE WHEN THE CURRENT IS LACKING HAS BEEN SET ON THE LOW VOLTAGE CONTROL CIRCUIT. FOR THE PERFECT INSULATION OF ALL THE ELECTRIC ELEMENTS AND THE REMARKABLE RESISTANCE OF THE ALUMINIUM TREATMENT, COUPLED WITH THE MATERIAL USED, OUR MACHINES CAN BE INSTALLED TO WORK INSIDE MOIST PREMISES.

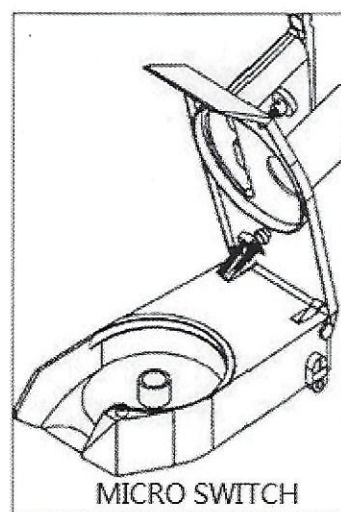

2. PERFORMANCE PARAMETER

2.1. TECHNICAL FEATURES

<u>MODEL</u>	<u>DIMENSIONS</u> <u>CM.</u>	<u>WEIGHT</u> <u>KG.</u>	<u>POWER</u> <u>WATT</u>	<u>ELECTRICAL</u> <u>CONNECTION</u>	<u>REVS</u> <u>DISC</u>
HLC-300	57X23X51	22.50	550	110/1/50~60 220~240/1/50~60 380/1/50~60	270

2.2. SUPPLY CONDITIONS AND DISPOSAL OF PACKINGS

THE CUTTING MACHINE IS PACKED IN A STURDY CARDBOARD BOX WITH INTERNAL SHAPED EDGES WHICH GUARANTEE THE PERFECT INTEGRITY OF THE MACHINE DURING TRANSPORT.

ALL THE PACKING COMPONENTS (CARTON, FOAM, STRAPS, AND SO ON) CAN EASILY BE DISPOSED OF AS HOUSEHOLD RUBBISH

3. INSTALLATION

3.1. SETTING THE MACHINE

THE MACHINE CONNECTION AND THE SETTING AT WORK MUST BE MADE BY SKILLED PERSONNEL.

WARNING: BOTH THE SYSTEM AND LOCATION WHERE THE EQUIPMENT HAS TO BE SET MUST COMPLY WITH THE REGULATIONS FOR THE ACCIDENT PREVENTION AND ELECTRICAL REGULATIONS ICE FORCE.

THE MANUFACTURER DECLINES ANY AND ALL RESPONSIBILITY FOR DIRECT OR INDIRECT DAMAGES WHICH MAY ENSUE FOR NON-COMPLIANCE WITH THE ABOVE MENTIONED REGULATIONS.

SET THE EQUIPMENT ON A WIDE, LEVELLED, DRY AND FIXED FACE, FAR FROM HEAT SOURCES AND WATER SPRAYS.

3.2. ELECTRIC CONNECTIONS

THE EQUIPMENT IS SUPPLIED WITH AN ELECTRIC CABLE TO BE CONNECTED TO A MAGNETO-THERMIC MAIN SWITCH WHICH STOPS THE MACHINE WHEN THE OPERATOR COMES IN FORTUITOUS CONTACT WITH THE ROTATING ELEMENTS.

IT IS IMPERATIVE THAT THE EQUIPMENT IS WELL GROUNDED ACCORDING TO THE REGULATIONS IN FORCE. THE MANUFACTURER DECLINES ANY AND ALL RESPONSIBILITY FOR DIRECT AND INDIRECT DAMAGES WHICH MAY ENSUE FOR NON-COMPLIANCE WITH THE REGULATIONS IN FORCE.

3.3. SAFETY MEASURES AND TRAINING THE FINAL USER

THE SKILLED PERSONNEL IN CHARGE OF THE INSTALLATION AND ELECTRIC CONNECTIONS OF THE EQUIPMENT IS RESPONSIBLE OF THE TRAINING OF THE FINAL USER, WHICH MUST ALSO BE INFORMED ON THE SAFETY MEASURES TO COMPLY WITH. THIS INSTRUCTION MANUAL COMES WITH EACH EQUIPMENT.

4. USE OF THE EQUIPMENT

4.1. CONTROLS

THE CONTROLS AND PILOT LIGHT ARE SENT ON THE RIGHT SIDE OF THE BASE. (WHEN THE MACHINE IS LOCATED IN FRONT OF THE OPERATOR, THE CONTROL DEVICE IN THE OPERATOR'S RIGHT HAND.)

1. GREEN BUTTON FOR STARTING THE MACHINE
2. RED BUTTON FOR STOPPING THE MACHINE

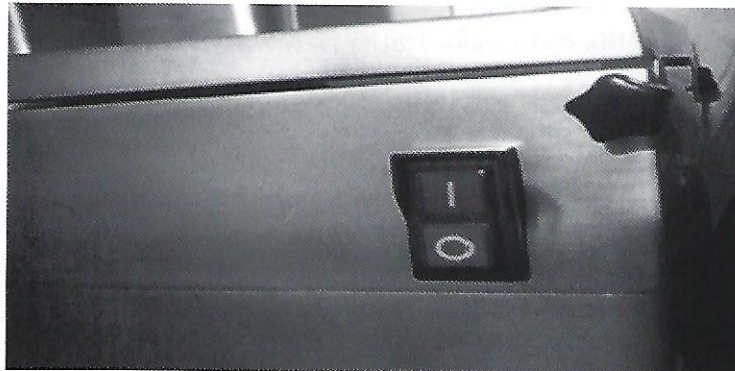

4.2. SETTING THE DISCS ON THE MACHINE

ROTATE THE KNOB AS SHOWN IN FIGURE N.1 AND OPEN THE COVER. SET FIRST THE PLASTIC EJECTING DISC (2), THEN INSTALL THE DISC SELECTED FOR THE CUTTING . CLOSE THE COVER AND REVERSE THE ROTATION OF THE HANDLE. WORK ON THE START BUTTON TO AUTOMATICALLY HOOK THE DISCS IN THE CORRECT POSITION.

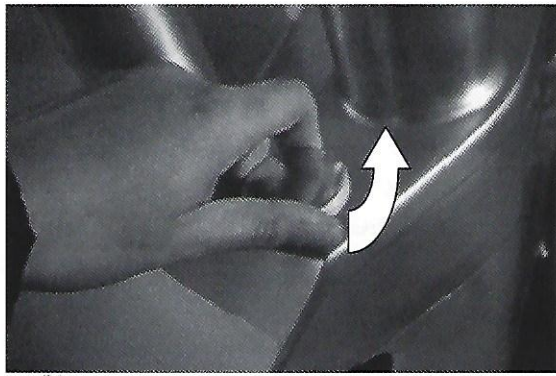

COVER OPENING (1)

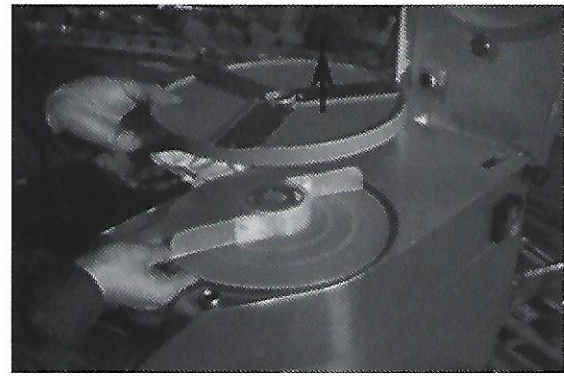

DISC POSITION (2)

ATTENTION TO DISC BLADES!!

4.3. SETTING AND CUTTING THE FOOD

LIFT THE HANDLE AND SET THE FOOD INSIDE THE OPENING AS SHOWN IN FIGURE N.3, THEN PUT DOWN THE HANDLE, PRESS THE GREEN START BUTTON WITH YOUR RIGHT HAND, AND WITH YOUR LEFT HAND, LIGHTLY MOVE THE HANDLE DOWNWARDS UNTIL FOOD IS FULLY USED UP.

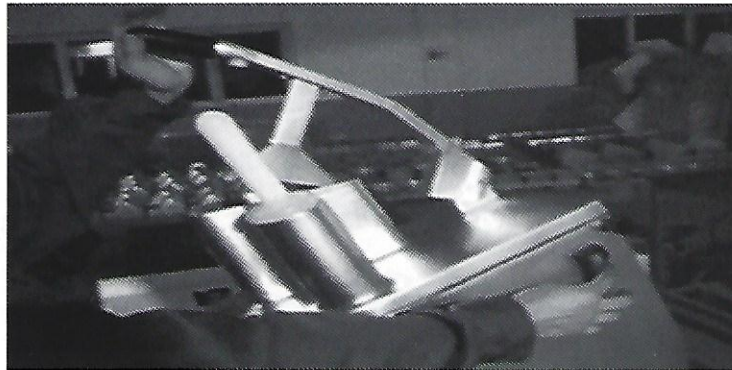

(3)

LIFT THE HANDLE TO INTRODUCE OTHER FOOD.

THE MACHINE WILL AUTOMATICALLY STOP WHEN RAISED THE HANDLE, AND THE MACHINE WILL AUTOMATICALLY WORK WHEN PUT DOWN THE HANDLE.

ROUND INLET IS USED FOR CUTTING SLENDER VEGETABLES SUCH AS CARROTS, CUCUMBER.

WARNING: NEVER USE THE HAND, BUT PRESS THE VEGETABLE WITH THE PESTLE SUPPLIED.

4.4. RELEASE AND REPLACEMENT OF THE DISCS

TURN THE KNURLED HANDLE AND LIFT THE COVER. (FIG.1)

TURN THE DISC ANTICLOCKWISE AND COVER THE CUTTING EDGE WITH APPROPRIATE MATERIAL AS (RUBBER, FABRIC, ETC), AND THEN GET OFF THE DISCS FROM BOTTOM TO UP WITH HAND.



(4)

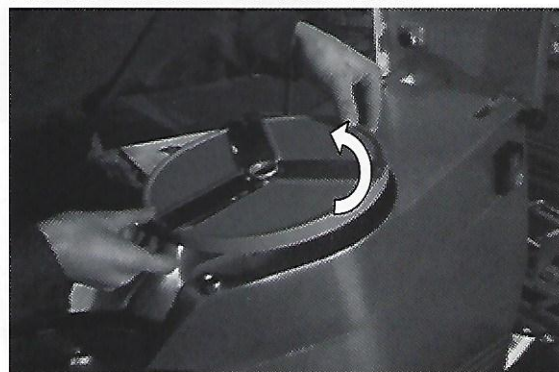

(5)

5. CLEANING AND MAINTENANCE OPERATIONS

5.1. GENERALITIES AND PRODUCTS FOR CLEANING

BEFORE CARRYING OUT ANY CLEANING OR MAINTENANCE OPERATIONS, CHECK TO MAKE SURE THAT THE MAINS SWITCH BE OFF AND THE SUPPLY PLUG DISCONNECTED FROM THE MAINS.

ACCURATELY CLEAN THE EQUIPMENT AND THE DISCS EVERY DAY FOR A CORRECT OPERATION AND LIFE OF THE EQUIPMENT.

THE DISCS, AND THE PLASTIC EJECTOR, CAN BE REMOVED FOR WASHING UNDER A WARM WATER JET. CLEAN THE MACHINE, AND ABOVE ALL WHERE THE DISCS REST, WITH A CLOTH OR A SPONGE WET WITH WARM WATER, ACCURATELY REMOVE ALL WASTES TO PREVENT THE DISCS FROM CHANGING THEIR POSITION.

OPEN THE COVER AND LOOSEN THE 2 PINS AS SHOWN IN FIG.6. REMOVE THE COVER AND WASH UNDER A WATER JET.

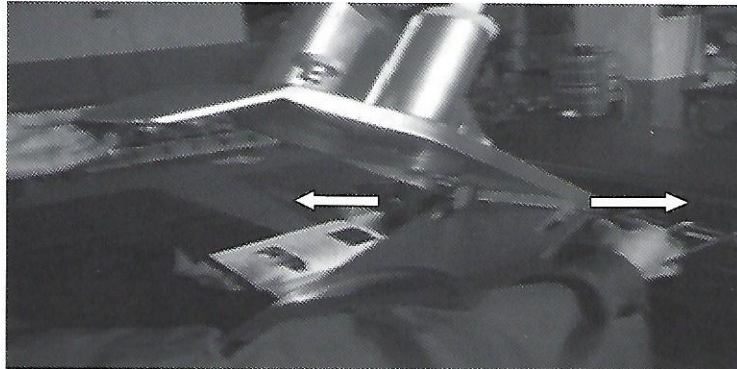

(6)

CLEAN THE SURFACES WITH WATER AND SOAP, ALCOHOL, DETERGENTS WITHOUT ABRASIVES OR SUBSTANCES BASED ON CHLORINE OR SODA (CHLORINE WATER, MURIATIC ACID).

NEVER USE ABRASIVES, STEEL WOOL, OR SIMILAR PRODUCTS AS THEY MAY BRING DAMAGES TO THE PAINT, THE COAT, OF THE MACHINE BODY.

FOR CLEANING, USE NON-TOXIC PRODUCTS AND ONES THAT GUARANTEE THE BEST HYGIENE.

5.2. OPERATIONS IN THE CASE OF FAILURES

1. WHEN PRESS THE GREEN BUTTON, IF THE LIGHT IS DARK, CHECK WHETHER THE COVERING OF MACHINE COVER TIGHTLY; IF THE LIGHT IS BRIGHT, THE MACHINE CAN NOT WORK, CHECK WHETHER HANDLE DOWN; IF STILL CAN'T WORK, THEN CUT OFF THE POWER AND CONTACT THE SERVICE CENTER.

2. WHEN THE MACHINE DOES NOT HAVE POWER OR BLADE RUN SLOW, OPEN THE MACHINE BOTTOM, ACCORDING TO THE FOLLOWING CHART METHOD TO ADJUST MOTOR TENSION BELT (2~3 MONTHS TO ADJUST THE NEW MACHINES TENSIONING BELT, THE OLD MACHINE IS OFTEN GIVEN). THE GUARANTEE PERIOD OF INSTALL NEW BELT ON THE MACHINE IS 9 MONTHS AFTER MANUFACTURED. THE NON-PROFESSIONALS DO NOT DISASSEMBLE THE MACHINE.

1) REMOVE THE BOTTOM



2) REMOVE THE BRACKET

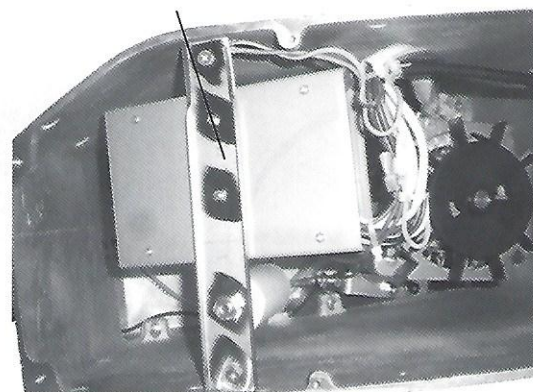

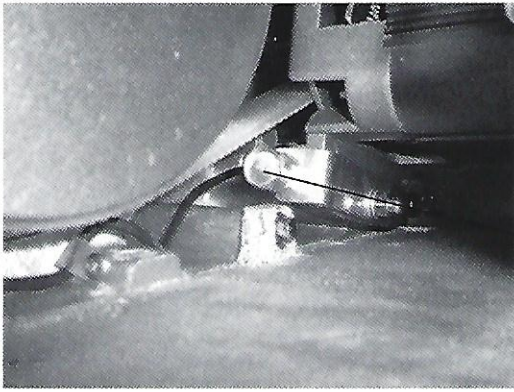

3) BY ADJUSTING THE SCREW TO
ADJUST THE BELT TENSION

5.3. MACHINE IDLE FOR A LONG TIME

SHOULD THE MACHINE BE IDLE FOR A LONG TIME, DISCONNECT THE MAIN WALL SWITCH AND CLEAN THE MACHINE AND ITS ACCESSORIES ACCURATELY. USE WHITE VASELINE OIL (OR SIMILAR PRODUCTS) TO PROTECT ALL THE MACHINE'S ELEMENTS.

WE ADVISE COVERING THE MACHINE WITH A NYLON (OR SIMILAR) CLOTH.

6. DISCS

IN ORDER TO ACHIEVE A RANG OF DIFFERENT SECTIONS AND SIZE, THE MACHINE FUNCTION IS APPLICABLE TO SEVERAL DIFFERENT DISCS AS WELL AS VEGETABLES AND FRUITS. (SUCH AS APPLES, PEARS, BANANAS, ETC.)

- | | |
|--------------------------------------|--------------------------|
| 6.1 SLICING BLADE (WITH THE MACHNE) | P2, P4 |
| 6.2 GRATING BLADE (WITH THE MACHINE) | H3, H4, H7 |
| 6.3 JULIENNE BLADE (OPTION) | HU2.5, HU4, HU8, HU10 |
| 6.4 DICING BLADE (OPTION) | D8, D10, D12, D20 |
| 6.5 FRENCH BLADE (OPTION) | T8, T10 |
| 6.6 SLICING BLADE (OPTION) | H8, H10, H14, E1, E2, E5 |
| 6.7 RIPPLE BLADE (OPTION) | PB2, PB4 |
| 6.8 POWER BLADE (OPTION) | FM |

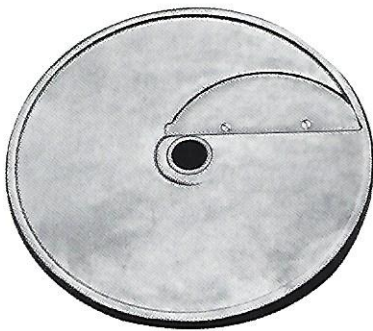

E1 E2 E5

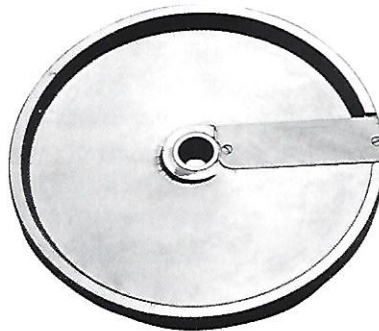

H8 H10

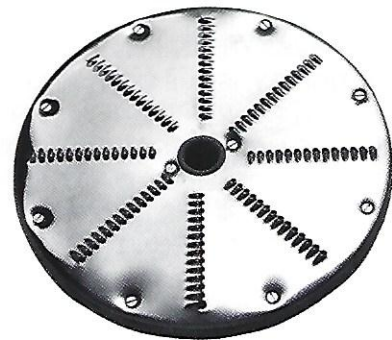

H3 H4 H7

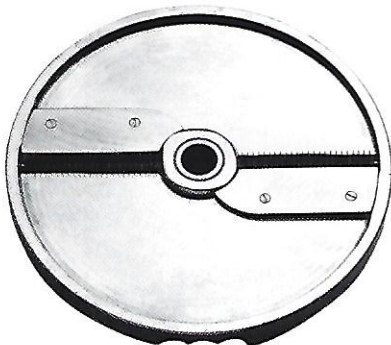

HU2.5 HU4 HU8 HU10

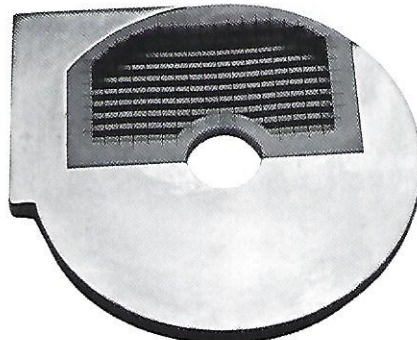

D8 D10 D12 D20

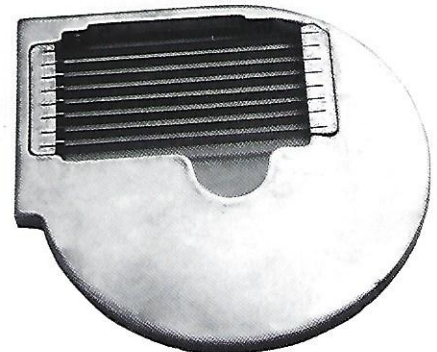

T8 T10

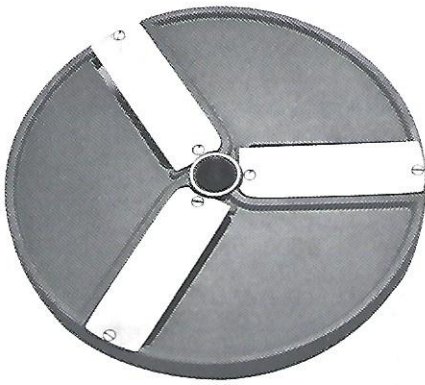

P2

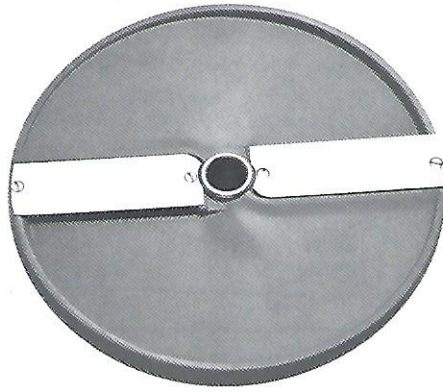

P4

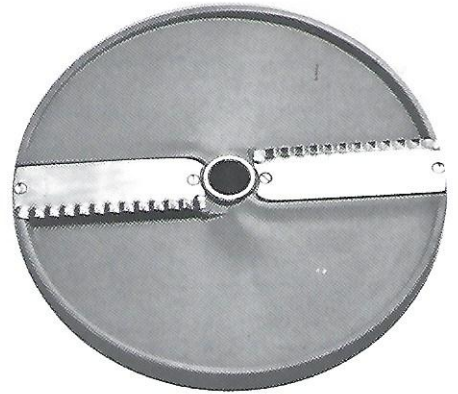

PB4

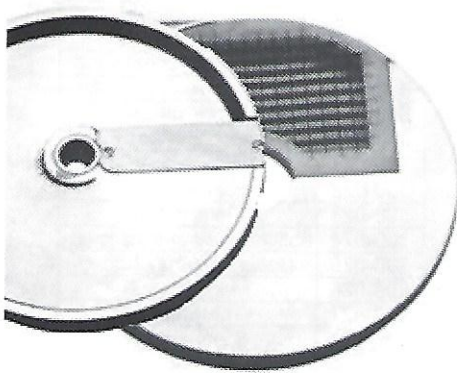

COMPOSE H8 H10
D10 D12 D20
D8 D10 D12 D20
COMPOSE H8 T8
H8 T10
H10 T8
H10 T10

7. EXPLODED DRAWING

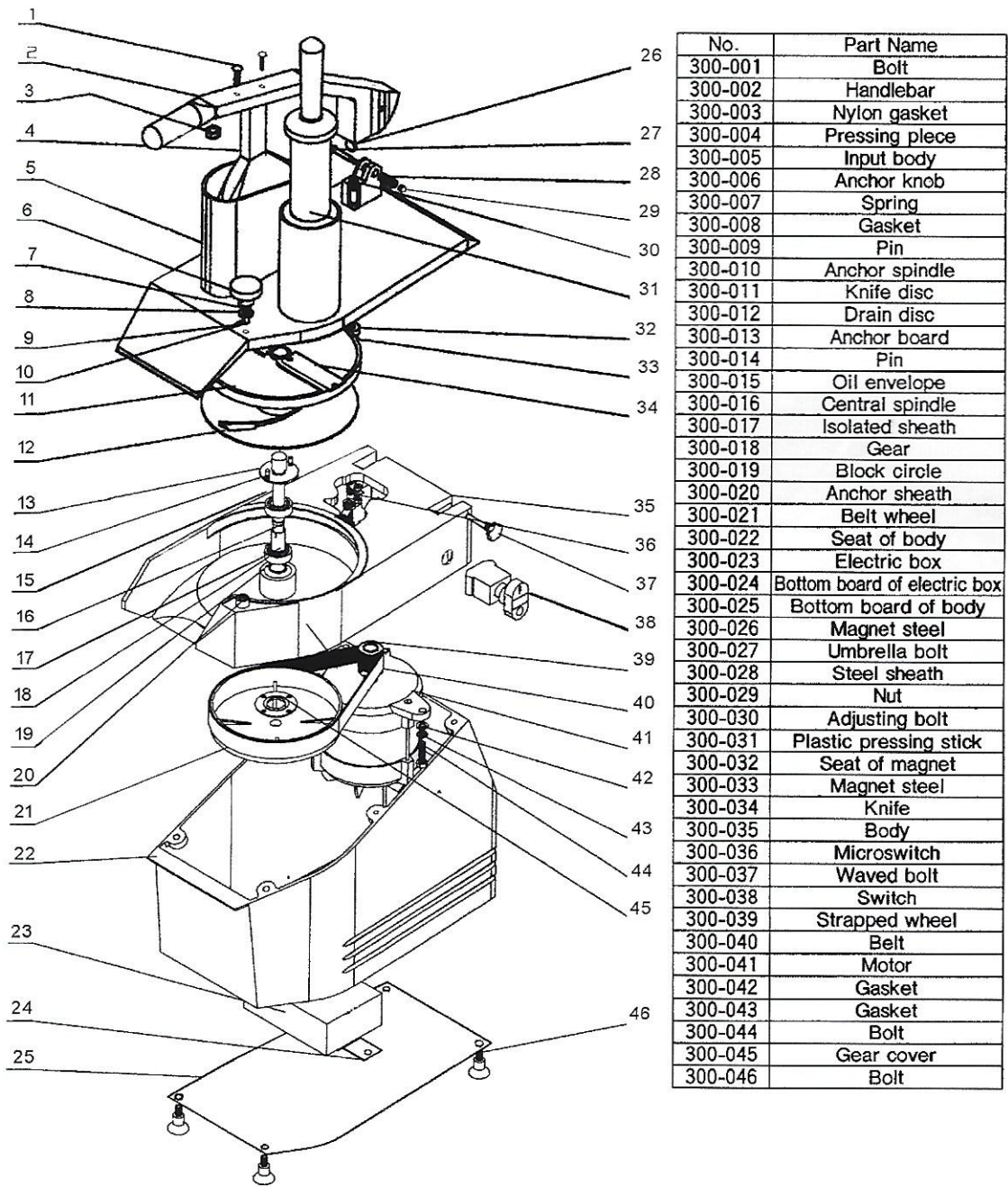

8. ELECTRICAL DRAWING

