

EN 2/3/4 DOOR VISICOOLERS
OPERATING MANUAL



EN TECHNICAL FEATURES OF 2/3/4 DOOR VISI/COOLERS

- 1- Canopy
- 2- Doors
- 3- Shelves
- 4- Pilasters
- 5- Interior lighting
- 6- Power compartment
- 7- Electronic thermostat (optional)
- 8- Adjustable feet

NOTE: The information and pictures given above are optional. They may vary due to models and versions.

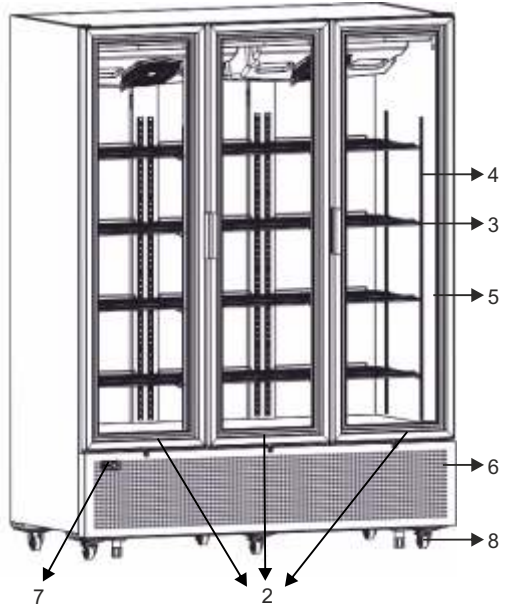
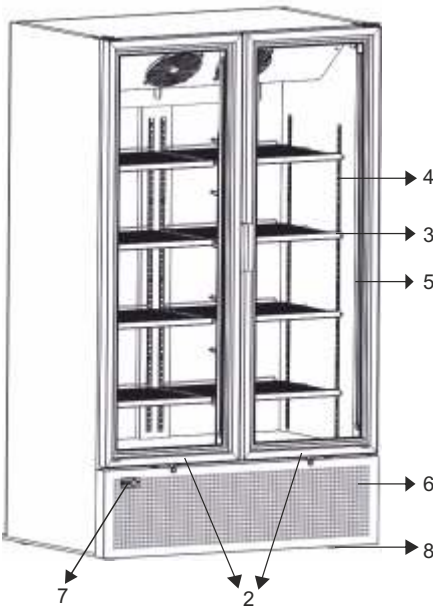
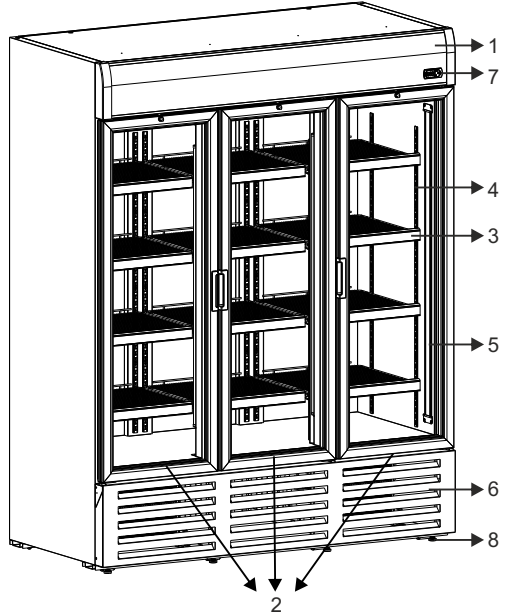
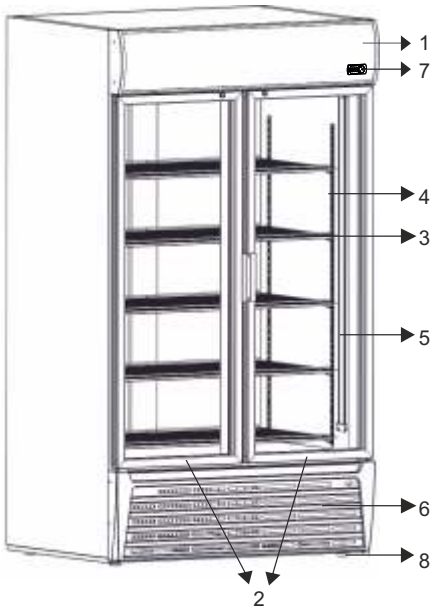

1. CONTENTS

Part 1. Contents

Part 2. Introduction

Part 3. Precautions And Safety Instructions Before The Initial Start-Up

Part 4. Technical Features of Double Door Visi/Coolers

Part 5. Assembly of Double Door Visi/Coolers/ The initial Start-up

Part 6. Operating Double Door Visi/Coolers

Part 7. Cleaning, Maintaining and Transporting Double Door Visi/Coolers

Part 8. Trouble Shooting

Part 9. Only for model with electronic control system

Part 10. Compliance Norms

2. INTRODUCTION

This operating manual has been designed to facilitate the use of your 2/3/4 door visi/cooler with maximum efficiency over the years. In all of the manufacturing processes "**environmentally-friendly**" technologies are used as well as materials and refrigerants that are not harmful to the nature. Please read this manual carefully before you start operating your visi/cooler in order to ensure maximum efficiency from this product that has been manufactured to serve you over the years.

As an initial step, please carefully read this manual thoroughly in order to ensure maximum efficiency from your visi/cooler and prevent user defects.

Detect the visi/cooler immediately on delivery for any damage. In case of any damage, contact with your authorized dealer within 24 hours.

Attention: It requires a lapse of minimum 2 hours after any transportation before you start operating your visi/cooler. If the visi/cooler has remained in an environment, the temperature of which was below 0 °C for a long period, allow for the compressor temperature to reach beyond +5 °C before re-operating the visi/cooler.

4. TECHNICAL FEATURES OF 2/3/4 DOOR VISI/COOLERS

TECHNICAL FEATURES	Operating Temperature °C	Internal Dimensions WxDxH (mm)	External Dimensions WxDxH (mm)	Max. Shelf Load (Net) Kg
S220 BB	0 / +10	796x362x751	885x515x889	47
S220 BB HD	0 / +10	796x362x751	885x540x885	47
S330BB	0 / +10	1267x408x750	1350x520x865	43/21
S330BB HD	0 / +10	1267x408x750	1353x522x865	43/21
S340BB	0 / +10	1267x408x750	1350x520x890	43/21
S340BB HD	0 / +10	1267x408x750	1353x524x890	43/21
S880SC TD	0 / +10	805x725x1370	880x861x2000	80
S880SC DD	0 / +10	805x640x1370	880x821x2000	80
S880SC TD SLIM	0 / +10	805x615x1370	880x751x2000	71
S880SC DD SLIM	0 / +10	805x530x1370	880x711x2000	71
S880 WOC TD SLIM	0 / +10	805x615x1370	880x751x2000	71
S900SC TD	0 / +10	1028x591x1355	1103x728x2000	78
S900SC DD	0 / +10	1028x508x1355	1103x689x2000	78
S1000SC TD	0 / +10	915x725x1355	990x861x2000	92
S1000SC DD	0 / +10	915x640x1355	990x821x2000	92
S1200SC TD	0 / +10	1028x725x1355	1103x861x2000	104
S1200SC DD	0 / +10	1028x640x1355	1103x821x2000	104
S1300SC TD SLIM	0 / +10	1125x622x1571	1200x762x2100	50
S1300SC TD SLIM WOC	0 / +10	1125x622x1571	1200x762x2004	50
S1300SC	0 / +10	1125x640x1385	1200x834x2160	55
S1300SC DD	0 / +10	1125x640x1385	1200x834x2080	55
S1500SC WOC 2D	0 / +10	1400x555x1545	1500x714x2023	64
S1500SC WOC 3D	0 / +10	1400x555x1545	1500x714x2023	42
S1500SC WOC 4D	0 / +10	1400x555x1545	1500x714x2023	42
S1600SC WOC 2D	0 / +10	1500x623x1355	1600x745x2042	46
S1600SC WOC 3D	0 / +10	1500x623x1355	1600x745x2042	46
S1600SC 2D	0 / +10	1500x623x1355	1600x745x2042	64
S1600SC 3D	0 / +10	1500x623x1355	1600x745x2042	42
S1600SC THD	0 / +10	1500x623x1355	1600x745x2042	46
S1600SC THD NAPOLEON	0 / +10	1500x623x1355	1600x756x2205	46
Inova1000	0 / +10	970x590x1407	1070x738x2156	44
Inova1200	0 / +10	1028x725x1355	1103x861x2000	104

Values specified above tables are given according to standard values and can vary by optional features.

Type label is located in the refrigerant part of the cabinet.

Please see the back page of the guide for the Type label sample.

Climate Classes			
Class	Temperature °C	Relative Humidity %	Dew Point °C
0	20	50	9,3
1	16	80	12,6
2	22	65	15,2
3	25	60	16,7
4	30	55	20,0
5	27	70	21,1
6	40	40	23,9
7	35	75	30,0
8	23,9	55	14,3

5. ASSEMBLING 2/3/4 DOOR VISI/COOLERS/ THE INITIAL START UP

Air circulation at the rear is required for the body to operate efficiently.

Move the visi/cooler backwards to place it properly.

Allow minimum 10 cm of space from the sides and the rear in order to ensure proper air circulation.

Clean your visi/cooler before operating it (See cleaning).

Your visi/cooler is now ready to plug in.

6. OPERATING THE 2/3/4 DOOR VISI/COOLERS

Clean your visi/cooler before operating it (See cleaning).

Since the location, ambient temperature and door-open time and frequency are the factors affecting the interior temperature of the visi/cooler, thermostat setting must be done accordingly.

Avoid blocking air circulation inside the visi/cooler, when loading the visi/cooler with food products. Otherwise undesired and extensive temperature variances may occur between the top and bottom compartments of the visi/cooler.

Control panel is located interior and consists of the following components:

Thermostat Setting Knob (optional):

It is used to regulate the internal temperature of your visi/cooler.

Thermostat adjustment is the most optimum adjustment in products with mechanical thermostat in factory defaults. It is recommended not to be replaced as long as it is not troubled with the inter product temperature. If you think that the product is not in desired temperature range you can make thermostat adjustment.

Thermostat setting must be done according to the features of the products to be preserved. Temperature setting can be done by means of turning the black thermostat knob on the control panel by the help of a coin or similar object. Turning the knob right decreases the internal temperature, whereas turning it left increases the internal temperature. Turning the knob leftmost stops the compressor, which in turn stops the chilling process, although the electric current to the visi/cooler is not cut off.

Lighting Switch (optional): It is used to turn on or turn off the both fluorescent lamps inside the body.

Installation and Removal of Slide-Doors (optional):

Carry out the following steps whenever slide-doors require installation and removal:

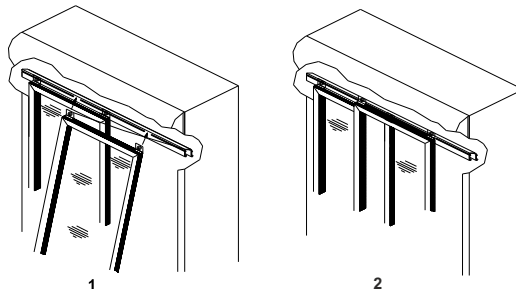

Start with dismantling the right door. It is not possible to dismantle the left door before the right one is removed.

There are two slots on the rear of the upper door tracks, each at an approximately 30 cm distance from the body sides. You can carefully determine the exact location with your hand in the door track). Position the door rollers under the slots. Hold the door on both sides and lift up in the track. Rollers will fit into the slots, allowing the door to elevate enough to get released off the lower track. (If the rollers are not perfectly positioned under the slots, the door cannot be lifted up, making it impossible to dismantle. In such a case, do not force to lift up the door as the upper and lower tracks can get damaged). While elevated, release the door off the lower track and slightly tilt out to dismantle and gently place down on the floor. Pay attention that the door return-spring is still attached on the door bracket.

If you want to detach the door, take out the spring end off the bracket hole and allow the spring gently return to the upper track. Do not release the spring at once, as it might cause injuries.

In order to reinstall the slide-doors, the door return spring must be reattached to the door bracket. Twist the free end of the spring 5-6 rotations in the opposite direction and insert in the bracket hole. When the spring end is twisted back 5-6 rotations, door return spring will gain proper tension, allowing for the reinstallation of door. Install the left door in between the upper rear aluminium track and lower rear track on the bottom plastic frame. Then install the right door in the front tracks. When you release the door, it closes fast with the tension on the spring. (**Important:** When you want to change the location of your visi/cooler, insert wooden door blockings between the doors and the plastic tracks underneath before transporting. Otherwise doors can get damaged upon getting off the tracks).

Hold-open Mechanism (optional)

Hold-open mechanism allows easy loading and unloading. When it requires holding the doors open, pull the RIGHT door leftmost. As it approaches the left side of the visi/cooler, it will fit into the gap between the aluminium thread and stopper on the door track and stay motionless. (In order to hold the left door open, pull it rightmost). Since the door won't close because of the spring tension, you can easily carry out loading and unloading.

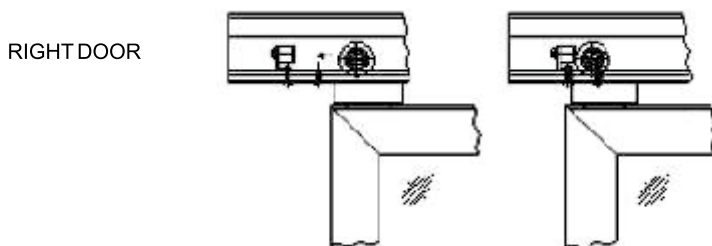

In order to close the door, pull in the closing direction. The door will come off the gap and return to its regular functioning.

Attention: If your visi/cooler is not sufficiently levelled, you may not operate this hold-open mechanism satisfactorily.

Adjusting the Slide-doors (optional)

Adjust the doors as follows if they are not properly aligned and if any gap remains at the sides when they are closed due to inclined floor surface or any other reason.

Remove the door as described above (do not release the spring off its bracket). Door adjustment washer is located between the roller and the nut. Therefore, grip the roller nut with an appropriate wrench and loosen the roller by the help of a flat screwdriver inserted in the slot on the front side. Adjust the door by inserting the adjustment washer into an upper or lower notch on the bracket. When you close the door, if there is a gap at the bottom, insert the right bracket washer into an upper notch, whereas insert the left bracket washer into an upper notch, if there is a gap at the top. If both washers are already fixed in the uppermost notches, do the adjustment by inserting one of the bracket washers into a lower notch.

Following each adjustment, reinstall the door as described above and check for the proper door alignment. If the door rubs against the bottom track due to misplaced washers, insert the adjustment washers of both rollers into the lowest notches and redo the adjustment.

Removing the Pallet and Inserting the Feet

• For models with metal sheet connectors

Your cabinet has been fixed with 4 metal brackets on wooden pallet before shipping . Please follow the instructions below before placing on its place.

Detach by unbolting 3 screws and remove metal bracket fixed cabinet and wooden pallet in front and back sections through a cutter device. Lean cabinet backwards from backside and remove pallet from underneath cabinet. Observe floor of cabinet and if not smooth, put product on scales.

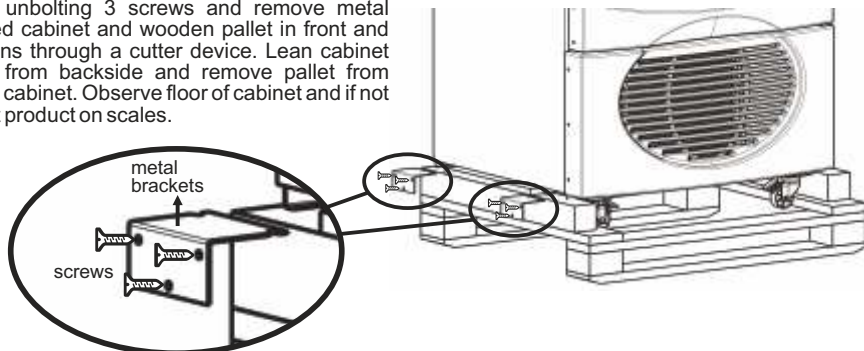

• For models without metal sheet connectors

Your visi-cooler has been delivered on a wooden pallet, fixed to the body at four corners.

Please carry out the following to detach the pallet before the body is set in its final operating location:

* Cut the 4 cable ties fixing to pallet to the cooler chassis by the means of a hand tool

* Carefully detach the pallet from the body base. Please find the feet of the visi/cooler provided interior. Insert them in the screwed sockets at the bottom of the visi/cooler and make the height adjustment.

Levelling the Visi/cooler

-Never remove the door blockings before the visi/cooler is placed in its final position.

-For the sliding doors function properly, the floor surface must be smooth and the body be levelled.

-For levelling: When the visi/cooler is slightly lifted up on the forklift, loosen the leveller bolts so as to reach the desired level of height above the floor. Gently place down the visi/cooler on the floor and check for levelling with a spirit level. If the visi/cooler tilts, readjust the leveller bolts. Upon perfect levelling, set the visi/cooler in its final operating position and remove the door blockings. Your double door visi/cooler is now ready to operate.

Mounting the Shelves:

There are shelves and shelf supports shipped inside the visi/cooler.

Carry out the following to mount the shelves

- Pilasters are numbered to provide height adjustment between the shelves in line with the product requirements. Place the shelf supports into corresponding notches on the pilasters. For an easy placement, use a pair of pincers to grip the support ends.
- Lay down the shelves on the visi/cooler floor. (Make sure that the right-angled (90°) side is at the rear).
- Hold the uppermost shelf; tilt one side and place on the hooks on the corresponding supports.
- Do the same for the remaining shelves and mount them all.
- If present, place the bottom shelf on the base of the visi-cooler.

Replacing the fluorescent lighting: (If your product has fluorescent lamp)

Before dismantling the lamp, always unplug your visi-cooler. After dismantling the lamp cover inside the visi-cooler, remove the lamp and always replace it with a lamp of the same features (length, power etc.)

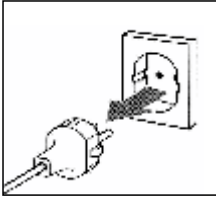

Unplug your visi-cooler.

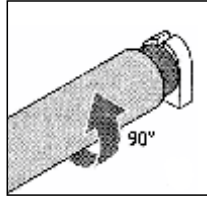

Rotate the lamp 90°.

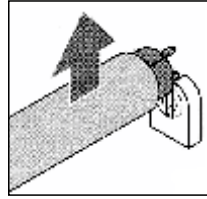

Remove the destroyed fluorescent lamp.

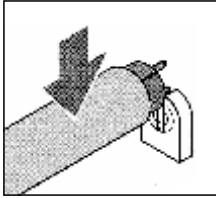

Place the new fluorescent lamp.

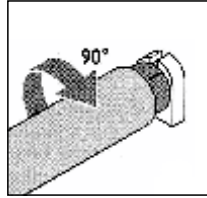

Rotate it 90°.

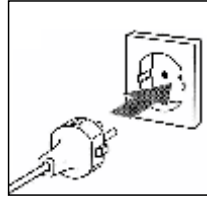

Switch on your visi-cooler again.

WARNING :

Your cooler can have a fluorescent lamp. If the fluorescent lamp don't illuminate or start to blinking, please call technical service to repair it in a short while. Please do not remain your cooler with non working lighting system.

WARNING:

Your cooler can have a LED illumination. If you face any problem with LED illumination, never try to repair it yourself. Inform an authorized service.

Only valid for glass door S 220 BB models with resistance (Check the name plate):

Glass doors of S 220 BB model has been designed with resistance to protect against sweating. Copper terminals on the interior right and left sides corresponding to the doors of cabinet should contact with copper plates on the sides of glass to prevent glasses getting hot and sweat. The user should ensure that doors are completely shut in order to fully run this function. 28V voltage on copper terminals on cabinet does not pose a danger for user health.

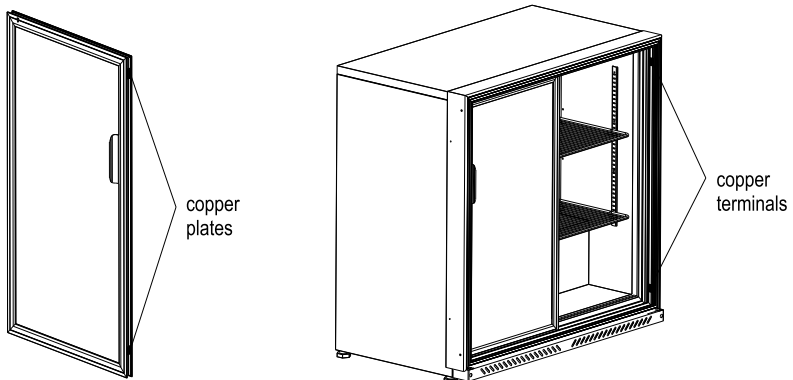

Defrosting:

Your visi/cooler is devised with an automatic defrosting system regulated by the thermostat. Defrost water accumulates in the channel underneath the evaporator; it is then carried to the drip tray by the help of a hose where it evaporates.

After defrosting, clean the body and make sure to wipe it out leaving no moist inside.

Plug the body again and reload the visi/cooler after one hour.

ONLY AVAILABLE FOR MODELS HAVING A LEAKAGE CURRENT RELAY :

There might be a leakage current relay in the feeder cable of your refrigerator.

To test if the leakage current relay works properly, press the yellow "TEST" button shown in following picture, the light will be off and the power of your refrigerator will be stopped when you press it . You can energize the refrigerator again by pressing "RESET" button.

In case any leakage current, the power of your refrigerator will be stopped automatically. If your refrigerator does not work and the lamp connected to plug in cable and shown in following picture does not shine, press the "RESET" button. The light will be on when your refrigerator works. If your refrigerator does not work again, please apply to authorized service.

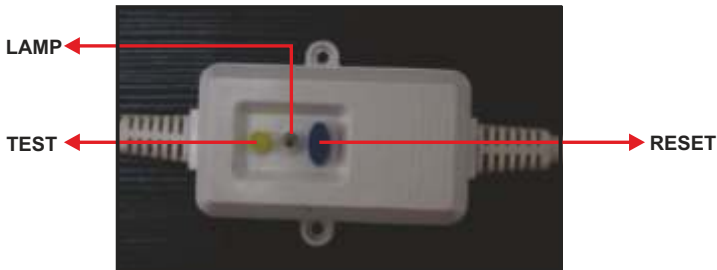

ONLY AVAILABLE FOR MODELS HAVING A VOLTAGE REGULATOR :

Voltage regulator of your refrigerator protects the unit against mains voltage fluctuations. When mains voltage fluctuates out of permissible range, voltage regulator turn off the power supply of the unit, end when mains voltage is back in the permissible range, the device will operate again. However, even in case mains voltage is back in permissible range instantly, the voltage regulator will turn on the power supply after a 3-minutes delay, to protect the device against voltage peaks and voltage dips.

7. CLEANING, MAINTAINING AND TRANSPORTING 2/3/4 DOOR VISI/COOLERS

To ensure higher efficiency, your visi/cooler must be regularly cleaned. Never use any cleaning agent that contains alcohol, scouring powder or powerful solvents. Always remove the plug from the mains socket before cleaning the visi/cooler. Add two teaspoons of baking soda (bicarbonate of soda) in 1-liter water and use this mixture to clean the visi/cooler. Clean the outer part with a wet cloth and then wipe it out.

If there is a drip tray for the water to accumulate after defrosting, wipe it once a year with a damp cloth.

Your visi/cooler has been designed not to make any frost. However if it is operated in a very damp environment or if its door/lid is frequently opened, some frost may occur. For manual defrosting: Adjust the thermostat to zero and unplug the visi/cooler. Remove the foodstuff from the visi/cooler and keep them somewhere cold or wrap them with an insulating material. Open the door/lid of your visi/cooler and allow for defrosting. Never use any scraper or sharp tools to remove frost or ice.

Attention: Attention! Never use any hot water, electrical heater, sharp tools or similar things as they may harm the visi/cooler.

Holidays /Stop Using For A While:

Do not unplug your visi/cooler if you are going on a holiday or stop using it for a short time.

If you are going on a holiday or stop using the body for a long time, unplug the visi/cooler and empty it. After defrosting, clean the visi/cooler and wipe it out with a cloth. Leave the door open to prevent door in the visi/cooler.

Transporting your visi/cooler:

Before relocating the body, unplug it from the mains socket, defrost it, wipe the interior walls and floor with a damp cloth, place the wooden blockings underneath the sliding doors and carry it in the normal position as it is used.

Attention: Expansion gas (C-Pentane) is used in the insulation system of the visi/cooler. When you dispose the body, it requires observing the applicable laws and rules of the country in which it is used.

Cleaning / maintining of your cooler's condenser must be done at least two times in a year by authorized service.

8. TROUBLE SHOOTING

• If the visi/cooler does not function;

- Check if the visi/cooler is properly plugged in the mains socket.
- Check if there is electric current to the mains socket
- Check if the fuse has blown out or if there is power failure.

• If the visi/cooler operates more frequently than desired;

- Check if the door is opened very frequently or left open for a long time.
- Check if the thermostat is set to cool more than desired.
- Check if the compressor compartment is blocked with dust, properly ventilated or it needs cleaning.

• If the visi/cooler does not cool enough;

- Check the temperature setting
 - Check if the door is opened very frequently or left open for a long time
 - Check if the internal air circulation is interrupted by overloading
- Cleaning / maintining of condenser might not done. (Please See Section7)

• If there is odor in the visi/cooler;

- Check if odorous foodstuff is stored in uncovered containers
- Check if the inside is properly cleaned

After having checked the above-mentioned points and carried out the recommendations, if your visi/cooler still functions unsatisfactorily, contact the nearest authorized service centre, informing your complaints as well as the model and serial number of your visi/cooler.

9. FOR CAREL ECOBOX and CAREL ENERGY SAVING CONTROLLED MODELS:



Control unit flashes for a few seconds in order to check if all connections are made correctly when the cooler is plugged in. This is normal, then the display will indicate current temperature. Set temperature has been adjusted to keep your beverages at optimum temperature, please do not attempt to change the settings.



CAREL ECOBOX



CAREL ENERGY SAVING TYPE 1



CAREL ENERGY SAVING TYPE 2



LIGHT : Pushing at least 0.5 seconds the keypad, the light status will be toggled. Pushing the keypad, and before than the light status will be toggle, the display will show "On" or "OFF" in order to warn how the light status is going to change.



DAY/NIGHT MODE : The thermostat changes its mode automatically. If the door continuously closed for more than 4 hour the thermostat mode will be night and the lights of cooler will be off. Lights can be on/off by pushing the light button. If the door is opened at the night mode, the mode will be day. At the night mode your cooler consume less energy. If you want to change the mode to the night you must to push the day-night button , after 60 second from the pushing the mode will be night.



ECO MODE: Pushing the keypad at least 3 seconds the ECO mode will toggle (if ECO mode is running then it will end, if ECO mode is waiting then it will start). Pushing the keypad, before then the ECO mode will toggle, the display will show "ECO" mode will toggle, the display will show "ECO" (Economy) or "nor" (normal) in order to warn how the functioning mode is going to change. If the thermostat is at the ECO mode, the cooler will consume less energy.

10. COMPLIANCE NORMS

Visi/Coolers described in this manual are manufactured and inspected in compliance with the

TS EN ISO 23953-1
TS EN ISO 23953-2
TS EN 60335-2-89
IEC 60335-2-89
2006/95/EC,
2004/108/EC

Made in Turkey

Type : **C-PENTANE**
Model :
Class :
Lamp Power :
Input :
Power / Current :
Refrig. :

Operation manuel is inside the unit.



0000000000000000



